



CATEYE STRADA CADENCE CC-RD200 Quick Start

Click the button and follow the instructions.

Thank you for purchasing our cyclocomputer CATEYE STRADA.

This Quick Start Manual explains how to set up the computer and how to install the unit on your bicycle.

Please set up the unit according to the specified procedure, then it will be ready for use as a cyclocomputer.



Before use, read the instruction manual that comes with the product thoroughly to the end to understand the functions of this unit, and to use it safely in a correct manner.

This PDF contains a movie file.

When you click on the movie screen, a message regarding security appears. Click the **“Trust in the text”** or **“Play”** button to close the message.

Click the screen again to play the movie.



CATEYE STRADA CADENCE Quick Start Manual

Contents

Click the item you wish to view.

Operation of buttons

Set up the computer by operating the buttons as follows.
Check the button position before you start setting up.

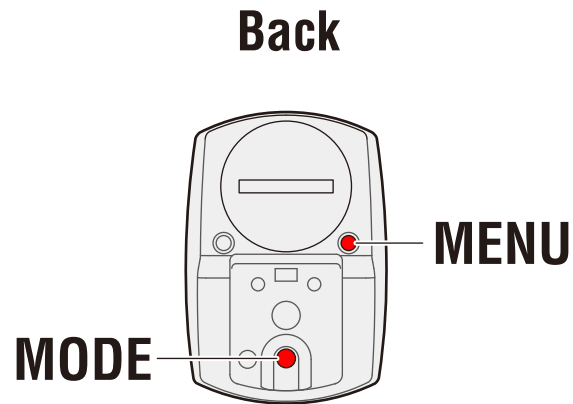

Press the **MENU** button and the **MODE** button on the back of the computer.



CATEYE STRADA CADENCE

Quick Start Manual

Setting up the computer

Clear all data (initialization)

Setting the speed unit

Entering the tire circumference

Setting the clock display

Setting the hour

Setting the minute

Measuring screen
(Setup completed)

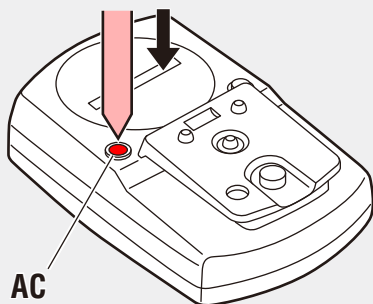

Clear all data (initialization)

Press the **AC** button on the back of the computer. After full lighting of the screen, the computer switches to the speed unit setting screen to start setup.



Full lighting



Setting the speed unit



CATEYE STRADA CADENCE

Quick Start Manual

Setting up the computer

Clear all data (initialization)

Setting the speed unit

Entering the tire circumference

Setting the clock display

Setting the hour

Setting the minute

Measuring screen
(Setup completed)



Setting the speed unit

Setting the speed unit

When the **MODE** button is pressed, either “**km/h**” or “**mph**” is selected for the speed unit display. Select the display of your choice.

After selecting, press the **MENU** button to proceed to the next step “Entering the tire circumference”.

km/h ↔ mph

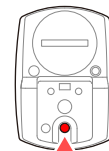

MODE

To the next step

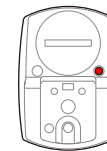

MENU



CATEYE STRADA CADENCE

Quick Start Manual

Setting up the computer

Clear all data (initialization)

Setting the speed unit

Entering the tire circumference

Setting the clock display

Setting the hour

Setting the minute

Measuring screen
(Setup completed)



Entering the tire circumference

Entering the tire circumference

Enter the tire circumference (mm) of your bicycle with 4 digits using the tire circumference reference table. Pressing the **MODE** button increases the value flashing, and pressing and holding the **MODE** button moves to the next digit.

After entering, press the **MENU** button to proceed to the next step "Setting the clock display".

To the next step

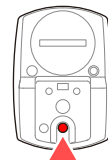

MODE

Move digit

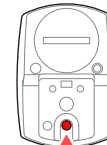

MODE

(Press and hold)

To the next step

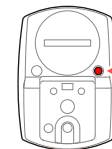

MENU



CATEYE STRADA CADENCE

Quick Start Manual

Setting up the computer

Clear all data (initialization)

Setting the speed unit

Entering the tire circumference

Setting the clock display

Setting the hour

Setting the minute

Measuring screen
(Setup completed)



Clock display

Setting the clock display

When you press and hold the **MODE** button, “24h” flashes. When the **MODE** button is pressed, either “12h” or “24h” is selected for the clock display. Select the display of your choice.

After selecting, press and hold the **MODE** button to proceed to the next step “Setting the hour”.

24h ↔ 12h



MODE

To the next step

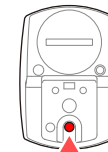

MODE

(Press and hold)



CATEYE STRADA CADENCE

Quick Start Manual

Setting up the computer

Clear all data (initialization)

Setting the speed unit

Entering the tire circumference

Setting the clock display

Setting the hour

Setting the minute

Measuring screen
(Setup completed)



Hour

Setting the hour

Pressing the **MODE** button increases the value flashing (“Hour” of the clock). Enter any value.

After entering, press and hold the **MODE** button to proceed to the next step “Setting the minute”.

To the next step

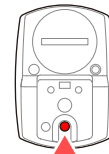

MODE

To the next step



MODE

(Press and hold)



CATEYE STRADA CADENCE

Quick Start Manual

Setting up the computer

Clear all data (initialization)

Setting the speed unit

Entering the tire circumference

Setting the clock display

Setting the hour

Setting the minute

Measuring screen
(Setup completed)



Minute

Setting the minute

Pressing the **MODE** button increases the value flashing (“Minute” of the clock). Enter any value (Pressing and holding **MODE** rapidly increases the value).

After entering, press the **MENU** button to switch to the measuring screen.

To the next step



MODE

Setup is completed
To the measuring screen



MENU



CATEYE STRADA CADENCE

Quick Start Manual

Setting up the computer

Clear all data (initialization)

Setting the speed unit

Entering the tire circumference

Setting the clock display

Setting the hour

Setting the minute

Measuring screen
(Setup completed)



Measuring screen

Now, setup of the computer is completed.

If the bracket and sensor are not installed on your bicycle, return to Contents, click “How to install the bracket” and “How to install the sensor”, and then install them according to the instructions.



CATEYE STRADA CADENCE

Quick Start Manual

How to install the bracket

How to install the bracket

[FlexTight™]

Click the screen to play.

- The Bracket being used in this movie is for wireless products and there is no wire attached.
- When you install the bracket band to your bicycle, tighten it so the wire will not be pinched by the stem or handlebar.

Prepare the following parts from the packaged items.

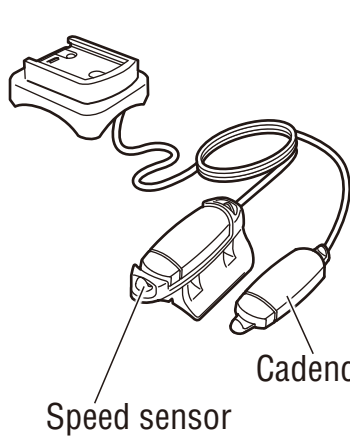

Speed sensor

Cadence sensor



Wheel magnet



Cadence magnet

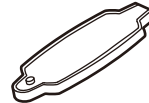

Sensor rubber pad

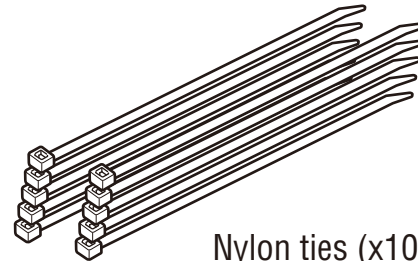

Nylon ties (x10)



CATEYE STRADA CADENCE

Quick Start Manual

How to install the sensor

Install the speed sensor

Install the wheel magnet

Install the cadence sensor

Install the cadence magnet

Adjust the positions of the sensor and magnet

Adjust the clearance between the sensor and magnet

Route the cable

Fixing the sensor and magnet
(Installation is completed)

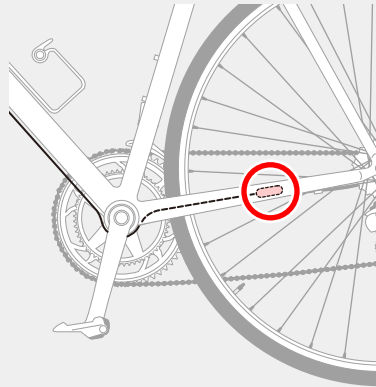

Install the speed sensor

Temporarily secure the speed sensor to the inside of the left chain stay of your bicycle with two nylon ties.

Tighten the speed sensor to such an extent that it can be moved.

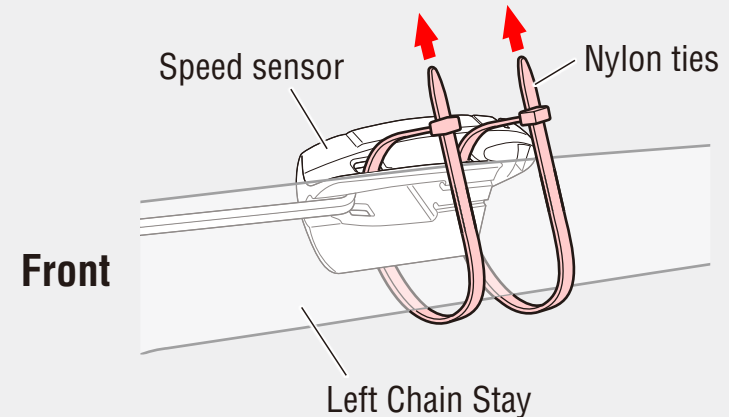



CATEYE STRADA CADENCE

Quick Start Manual

How to install the sensor

Install the speed sensor

Install the wheel magnet

Install the cadence sensor

Install the cadence magnet

Adjust the positions of the sensor and magnet

Adjust the clearance between the sensor and magnet

Route the cable

Fixing the sensor and magnet
(Installation is completed)

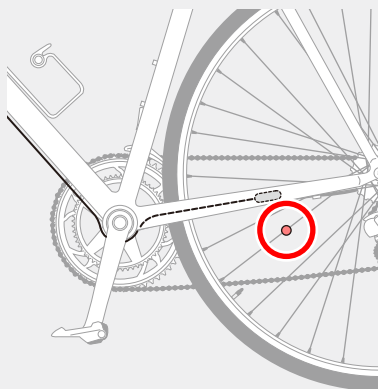

Install the wheel magnet

Temporarily secure the wheel magnet to the left spoke of the rear wheel.

Tighten the wheel magnet to such an extent that it can be moved.

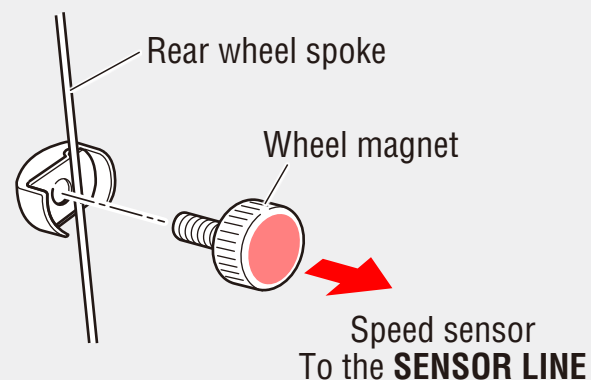



CATEYE STRADA CADENCE

Quick Start Manual

How to install the sensor

Install the speed sensor

Install the wheel magnet

Install the cadence sensor

Install the cadence magnet

Adjust the positions of the sensor and magnet

Adjust the clearance between the sensor and magnet

Route the cable

Fixing the sensor and magnet
(Installation is completed)

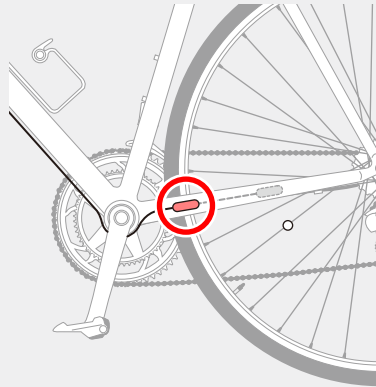

Install the cadence sensor

Temporarily secure the cadence sensor to the outside of the left chain stay of your bicycle with two nylon ties.

- * When the clearance with the cadence magnet is more than 3 mm, install the cadence sensor with sensor rubber pads in layers. When temporarily securing, keep allowance for sensor rubber pads.

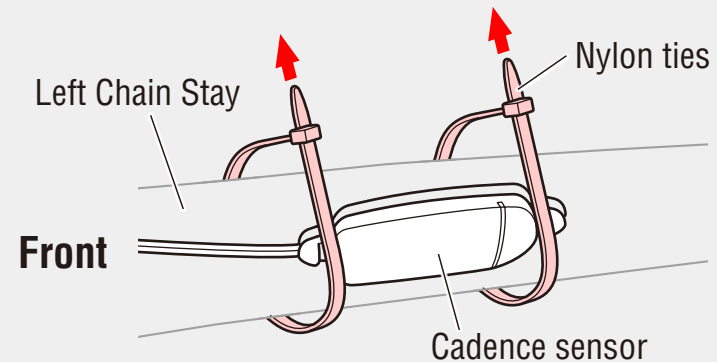



CATEYE STRADA CADENCE

Quick Start Manual

How to install the sensor

Install the speed sensor

Install the wheel magnet

Install the cadence sensor

Install the cadence magnet

Adjust the positions of the sensor and magnet

Adjust the clearance between the sensor and magnet

Route the cable

Fixing the sensor and magnet
(Installation is completed)

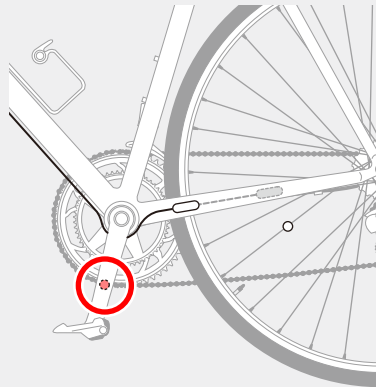

Install the cadence magnet

Temporarily secure the cadence magnet to the inside of the left crank with nylon ties.

Tighten the cadence magnet to such an extent that it can be moved.

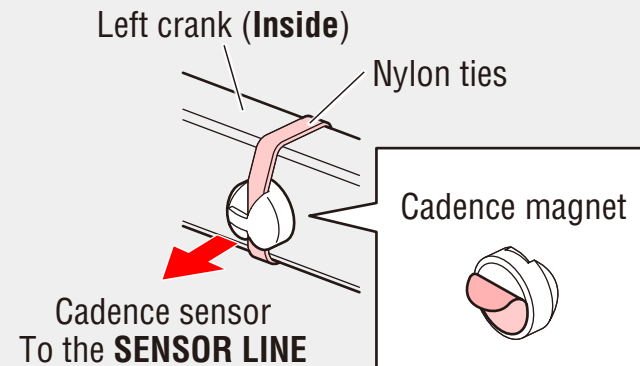



CATEYE STRADA CADENCE

Quick Start Manual

How to install the sensor

Install the speed sensor

Install the wheel magnet

Install the cadence sensor

Install the cadence magnet

Adjust the positions of the sensor and magnet

Adjust the clearance between the sensor and magnet

Route the cable

Fixing the sensor and magnet (Installation is completed)

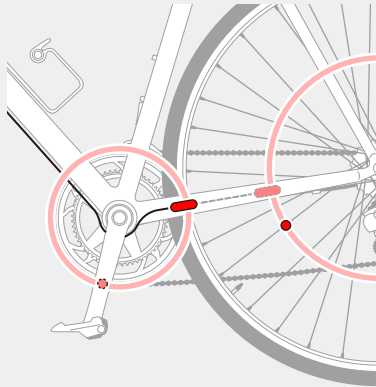

Adjust the positions of the sensor and magnet

Adjust the positions so that the wheel magnet passes through the **SENSOR LINE** of the speed sensor, and the cadence magnet passes through the **SENSOR LINE** of the cadence sensor.

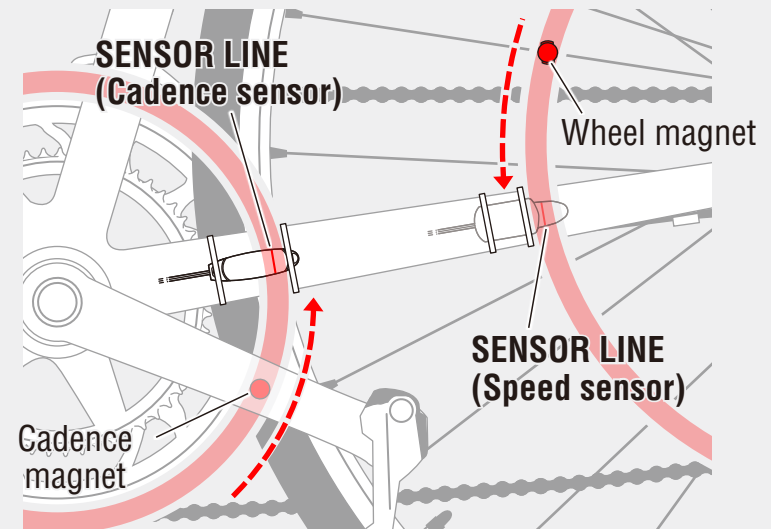



CATEYE STRADA CADENCE

Quick Start Manual

How to install the sensor

Install the speed sensor

Install the wheel magnet

Install the cadence sensor

Install the cadence magnet

Adjust the positions of the sensor and magnet

Adjust the clearance between the sensor and magnet

Route the cable

Fixing the sensor and magnet
(Installation is completed)

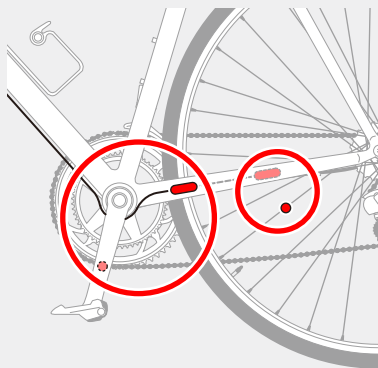

Adjust the clearance between the sensor and magnet

Adjust the clearances between the speed sensor and wheel magnet and the cadence sensor and cadence magnet, so that both of them are within 3 mm.

* When the clearance between the cadence sensor and cadence magnet is more than 3 mm, install the cadence sensor with sensor rubber pads in layers.

Left Chain Stay (Outside)

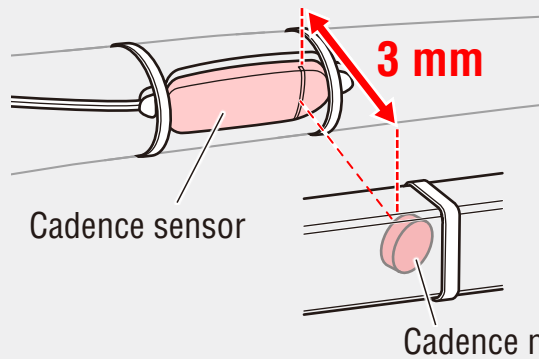

Left Chain Stay (Inside)

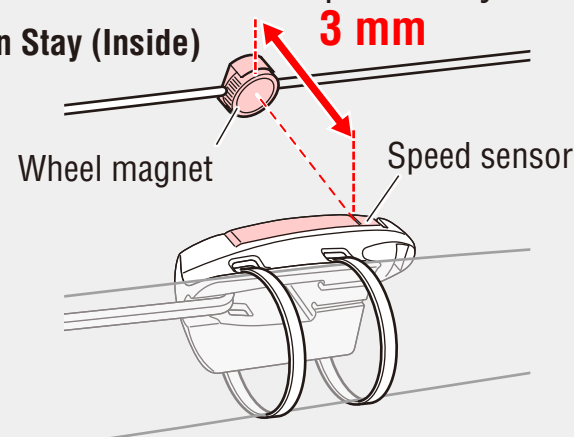



CATEYE STRADA CADENCE

Quick Start Manual

How to install the sensor

Install the speed sensor

Install the wheel magnet

Install the cadence sensor

Install the cadence magnet

Adjust the positions of the sensor and magnet

Adjust the clearance between the sensor and magnet

Route the cable

Fixing the sensor and magnet
(Installation is completed)

Route the cable

Fix the wire to the frame with nylon ties where applicable, and route it to the handle while winding around the brake cable. Cut off any excess nylon tie using a nipper.

Caution: Adjust this  section so that the wire is not stretched when you turn the handle.

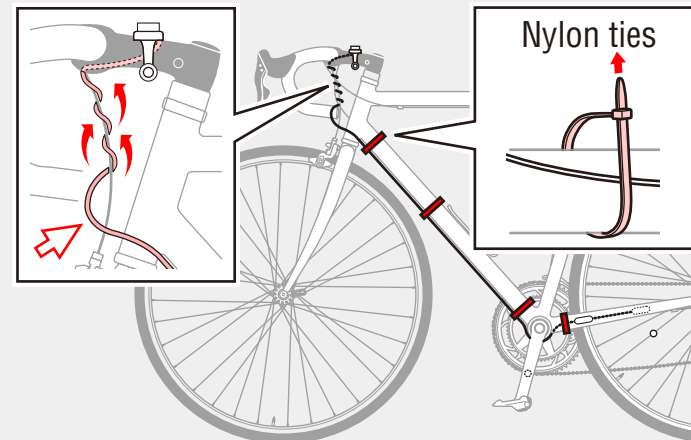



CATEYE STRADA CADENCE

Quick Start Manual

How to install the sensor

Install the speed sensor

Install the wheel magnet

Install the cadence sensor

Install the cadence magnet

Adjust the positions of the
sensor and magnet

Adjust the clearance between
the sensor and magnet

Route the cable

Fixing the sensor and magnet
(Installation is completed)

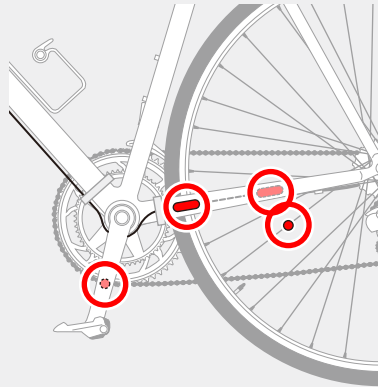

Fixing the sensor and magnet

Firmly tighten each sensor and magnet, and cut off any excess nylon tie using a nipper.

Now, sensor installation is completed. See how to install the bracket, and then complete the installation. When the computer is not set up, return to Contents, click “Setting up the computer”, and follow the instructions.



CATEYE STRADA CADENCE

Quick Start Manual

Setting up the computer

Tire circumference reference table

ETRTO	Tire size	L (mm)
47-203	12x1.75	935
54-203	12x1.95	940
40-254	14x1.50	1020
47-254	14x1.75	1055
40-305	16x1.50	1185
47-305	16x1.75	1195
54-305	16x2.00	1245
28-349	16x1-1/8	1290
37-349	16x1-3/8	1300
32-369	17x1-1/4 (369)	1340
40-355	18x1.50	1340
47-355	18x1.75	1350
32-406	20x1.25	1450
35-406	20x1.35	1460

ETRTO	Tire size	L (mm)
40-406	20x1.50	1490
47-406	20x1.75	1515
50-406	20x1.95	1565
28-451	20x1-1/8	1545
37-451	20x1-3/8	1615
37-501	22x1-3/8	1770
40-501	22x1-1/2	1785
47-507	24x1.75	1890
50-507	24x2.00	1925
54-507	24x2.125	1965
25-520	24x1 (520)	1753
	24x3/4 Tubular	1785
28-540	24x1-1/8	1795
32-540	24x1-1/4	1905

ETRTO	Tire size	L (mm)
25-559	26x1 (559)	1913
32-559	26x1.25	1950
37-559	26x1.40	2005
40-559	26x1.50	2010
47-559	26x1.75	2023
50-559	26x1.95	2050
54-559	26x2.10	2068
57-559	26x2.125	2070
58-559	26x2.35	2083
75-559	26x3.00	2170
28-590	26x1-1/8	1970
37-590	26x1-3/8	2068
37-584	26x1-1/2	2100
	650C Tubular 26x7/8	1920

ETRTO	Tire size	L (mm)
20-571	650x20C	1938
23-571	650x23C	1944
25-571	650x25C 26x1 (571)	1952
40-590	650x38A	2125
40-584	650x38B	2105
25-630	27x1 (630)	2145
28-630	27x1-1/8	2155
32-630	27x1-1/4	2161
37-630	27x1-3/8	2169
18-622	700x18C	2070
19-622	700x19C	2080
20-622	700x20C	2086
23-622	700x23C	2096
25-622	700x25C	2105

ETRTO	Tire size	L (mm)
28-622	700x28C	2136
30-622	700x30C	2146
32-622	700x32C	2155
	700C Tubular	2130
35-622	700x35C	2168
38-622	700x38C	2180
40-622	700x40C	2200
42-622	700x42C	2224
44-622	700x44C	2235
45-622	700x45C	2242
47-622	700x47C	2268
54-622	29x2.1	2288
60-622	29x2.3	2326

Measure the tire circumference (L) of your bicycle

Adjust the tire pressure properly. With the rider's weight applied on the bicycle, roll the wheel one tire revolution with reference to a marker such as the valve, and measure the travel distance on the ground.

